



MOUNT
 SHELVES ABOVE
 OR BELOW A
 SCREEN

BT8390-SA

ADJUSTABLE ACCESSORY MOUNTING ARM

The BT8390-SA allows B-Tech shelves and other accessory mounts to be fitted onto System X installations, making it the ideal solution for adding a VC camera to a twin screen setup. The arm hooks onto BT8390 mounting rails and can be positioned so that the mounted accessory is either above or below the screen(s). Featuring an adjustable extension arm that can be freely positioned anywhere along the length of the rail, the BT8390-SA is suitable for use with a large range of screen sizes.

SPECIFICATION

Max load (single adaptor)	4kg
Max load (when two BT8390-SA are used for large shelves)	15kg
Extension (from centre of screen)	Min: 249 - Max: 645mm
Colour	Black

FEATURES

- Suitable for a range of different accessory shelves and mounts
- Allows mounted accessories to be positioned above or below the screen(s)
- Adjustable extension arm for optimal positioning of mounted accessories
- Ideal for Apple TV® (4th Gen) when used in conjunction with BT7880
- Large shelves such as BT7032 can be mounted using 2x BT8390-SA
- Optional extension bar is included to increase height adjustment and accommodate larger screens
- Simple 'hook-on' design for quick and easy installation & removal



Allows mounted accessories to be positioned above or below the screen(s)



Ideal for VC cameras when used in conjunction with BT7863

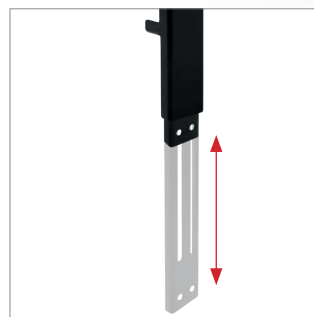

Adjustable extension arm for optimal positioning of mounted accessories



Large shelves such as BT7032 can be mounted using 2x BT8390-SA

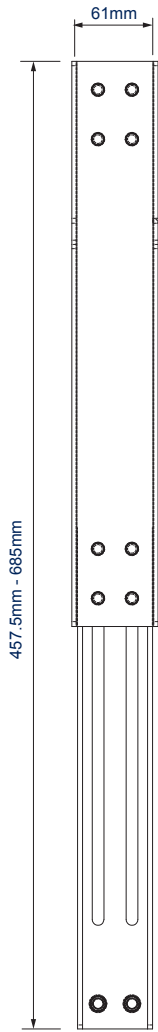

FRONT VIEW

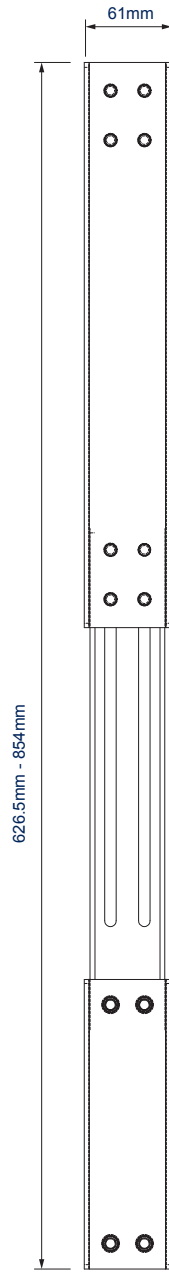

FRONT VIEW WITH EXTENSION BAR

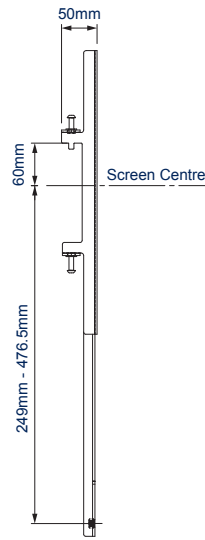

SIDE VIEW - BELOW RAIL

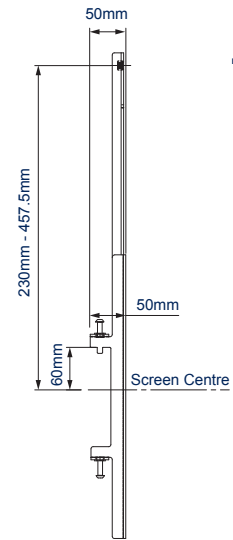

SIDE VIEW - ABOVE RAIL

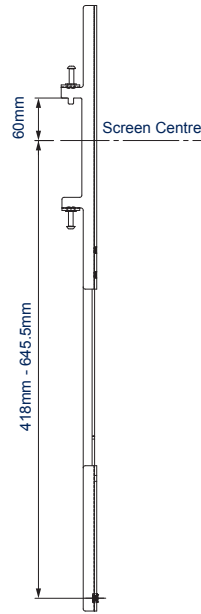

SIDE VIEW WITH EXTENSION BAR - BELOW RAIL

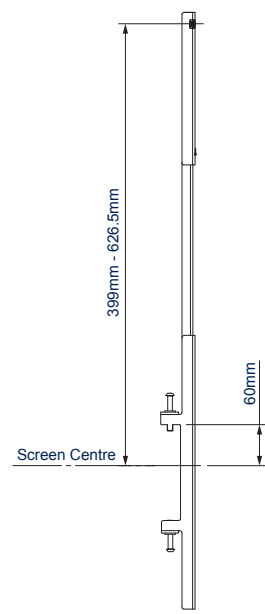

SIDE VIEW WITH EXTENSION BAR - ABOVE RAIL

PACKING INFORMATION

ORIGINAL DESIGN BY B-TECH - REGISTERED COMMUNITY DESIGN NO.: 004038040-0037

COLOUR:	ORDER REF:	EAN CODE:	MASTER CARTON QTY:	INNER CARTON QTY:	MASTER CARTON WEIGHT:	MASTER CARTON CUBE:
Black	BT8390-SA/B	5019318501692	10	0	23.5kg	0.041cbm

ACCESSORIES AND RELATED PRODUCTS

BT8390-030/050/070/150/175/200



Mounting Rail fits to columns, walls or poles for use in a wide range of installations

BT7863



Video Conferencing Camera Shelf fits a wide range of VC cameras and codecs

BT7032



Large AV Accessory Shelf for larger AV accessories such as Blu-Ray® players or laptops

BT7880



Wall Mount for Apple TV® for 4th Generation Apple TV players

© 2015 B-Tech Av Mounts. All rights reserved. This information is provided for informational purposes only. It is not intended to be used as a substitute for professional advice. B-Tech Av Mounts is not responsible for any damage or loss of data caused by improper use of its products. Any reproduction or transmission of any part of this specification is strictly prohibited unless prior written permission has been granted by B-Tech Av Mounts. SS-V2.1-BT8390-SA-210921