

# Bullet Junction Box

## TR-JB07-D-IN



### Specifications

Bracket	TR-JB07-D-IN
Application	Outdoor or indoor cable junction box for IPC23XX/222X、IPC74X and IPC252/26X series(Extra back outlet)
Dimensions	Φ125mm*125mm*55mm (4.92" x4.92"x2.17")
Weight	0.75kg(1.65lb)
Material	Aluminum alloy

### Dimension

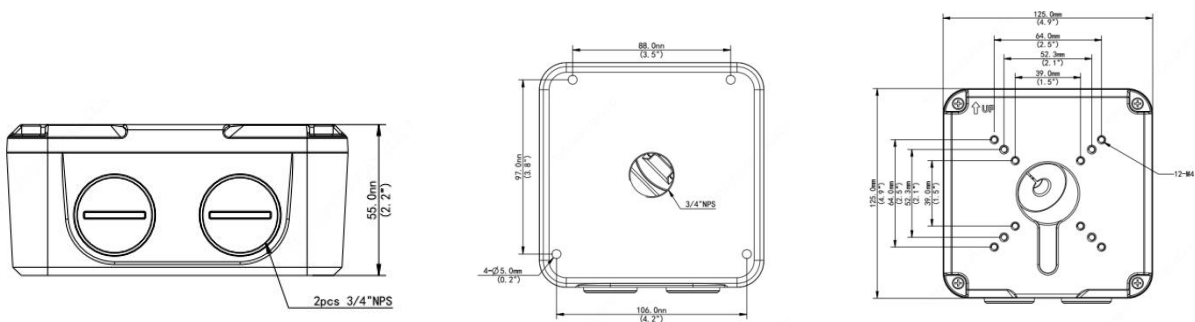

#### Zhejiang Uniview Technologies Co.,Ltd.

South Tower, Building 10, Wanlun Science Park, 88 Jiangling Road, Hangzhou, P.R.China 310051

Email: [overseasbusiness@uniview.com](mailto:overseasbusiness@uniview.com); [globalsupport@uniview.com](mailto:globalsupport@uniview.com)

<http://www.uniview.com>

©2019 Zhejiang Uniview Technologies Co.,Ltd. All rights reserved.

\*Product specifications and availability are subject to change without notice.