

Flat Screen Ceiling Mount with Adjustable Drop and Tilt

For more information please visit www.btechavmounts.com/BT8447

BT8447

Registered Design Number: 001713280-0036 / 403650



BT8447

Flat Screen Ceiling Mount with Adjustable Drop and Tilt

**Designed for extra-large screens
up to 65" (165cm) / 35kg (77lbs)**

- Fits screens with mounting patterns up to H: 825mm (32.5") x V: 500mm (19.7") including VESA® fixings up to 800 x 500mm
- Simple tilt adjustment +/-15°
- Unique 'Torsion-Tilt' mechanism*
- Adjustable ceiling drop: 668mm (26.3") - 943mm (37.1") in 25mm (1") increments
- Integrated cable management
- Security locking screws, Allen key and locking bars provided for secure installation
- Cover plate included for smart installation
- Simple 'hook-on' installation with all mounting hardware included
- Available in Black



Unique 'Torsion-Tilt' mechanism*
*Patent Pending

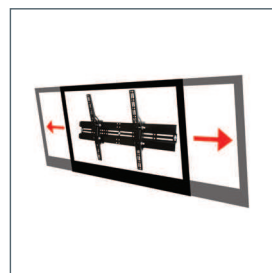

Post installation screen alignment



Security locking bar
(Padlock not included)

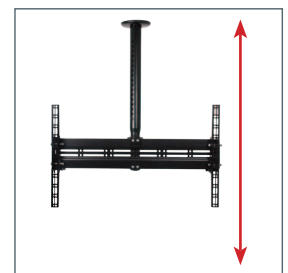

Ceiling drop: 668mm - 993mm in
25mm (1") increments

Flat Screen Ceiling Mount with Adjustable Drop and Tilt

For more information please visit www.btechavmounts.com/BT8447

BT8447

Registered Design Number: 001713280-0036 / 403650

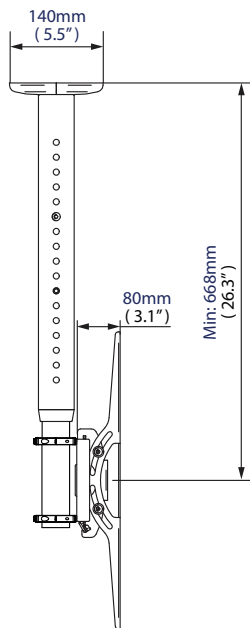

Side View - Minimum Drop

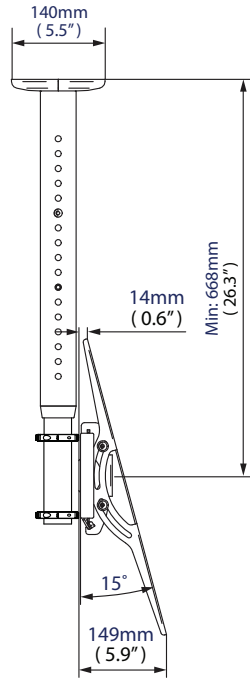

Side View - Interface Tilt

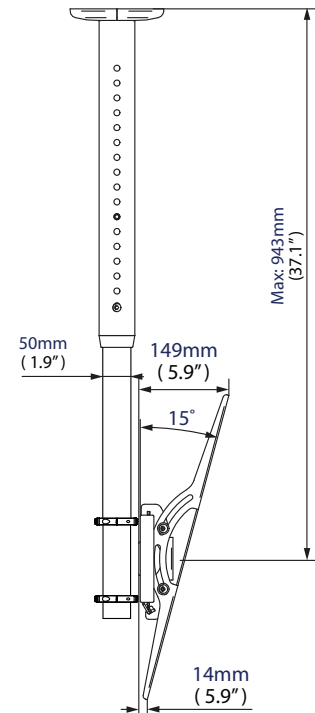

Side View - Maximum Drop

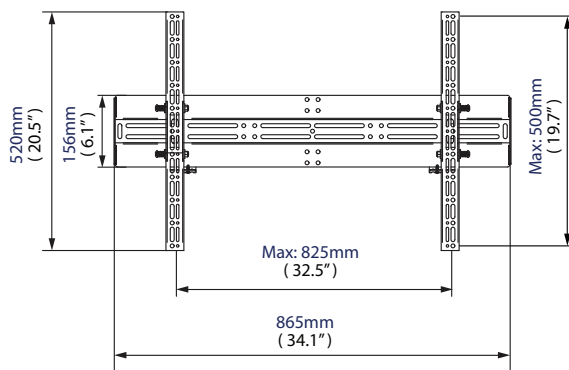

Flat Screen Interface

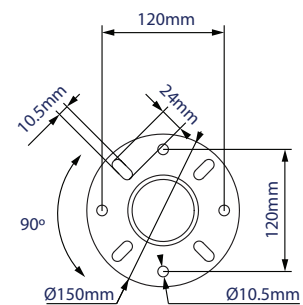

Ceiling Plate

Colour:	Order Ref:	EAN Code:	Master Carton Qty:	Inner Carton Qty:	Master Carton Weight:	Master Carton Cube:
Black	BT8447/B	5019318079573	1	N/A	10.104kg (22.275lbs)	2.75cuft (0.078cbm)

This information is intended as a guide only and reflects the current specification at the time of print.
B-Tech accepts no liability for the accuracy of the information contained in this document.